

TeLePriSM

Teaching and Learning Practices in Secondary Mathematics
Third Student Questionnaire (Autumn 2012)

Dear pupil,

You are being invited once again to take part in a research study run by the University of Manchester. The questionnaire you are about to complete is about your mathematics lessons in your school.

No-one else will see your answers to this questionnaire as it is **strictly confidential**. We are only asking you to enter your unique username, which will be given by your teacher, because we hope to match your responses to those you gave in previous surveys.

Please answer ALL questions as honestly as possible.

By completing and returning this questionnaire we take it that you are happy to take part in this research. As a small reward for your effort we will enter your username in a raffle to **win an ipod** at the end of the project!



Part A – About yourself and your school

Please complete the following questions about your school and yourself, by filling in the boxes. Your **username**, and **maths class name** should have been provided to you by your teacher.

1. My username is:

2. The name of my school is:

3. The name of my maths class/set is:

4. The name of my maths teacher is:

5. I have a second maths teacher, who is:

(If you only have one maths teacher, leave this box empty)

6. My year group is (please circle one): Year 7 Year 8 Year 9 **Year 10** Year 11

7. I am a:

8. Which is your favourite subject in school?

9. Which is your least favourite subject in school?

10. How do you rate your ability in the following subjects?

(Please circle what you think is appropriate in each line)

Mathematics	Poor	Average	Good	Excellent
English	Poor	Average	Good	Excellent
Science	Poor	Average	Good	Excellent

11. How has your ability in these subjects changed since last year?

(Please circle what you think is appropriate in each line)

Mathematics	I am worse now	I am the same	I am better now
English	I am worse now	I am the same	I am better now
Science	I am worse now	I am the same	I am better now

12. How often do your parents/carers do the following?

(Please circle the most appropriate number in each line)

	Never	Rarely	Sometimes	Often	All the time
Check whether you have done your homework	1	2	3	4	5
Help you with your homework	1	2	3	4	5
Praise or reward you for good grades	1	2	3	4	5
Reduce your rewards because of low grades	1	2	3	4	5
Find you a tutor to help you with your homework	1	2	3	4	5

Part B – Your feelings about Mathematics

1. Are you planning to study any more mathematics courses or units after this GCSE course? (e.g. AS, A2)? (Tick one statement only)

Yes	<input type="checkbox"/>	No	<input type="checkbox"/>	I don't know	<input type="checkbox"/>
-----	--------------------------	----	--------------------------	--------------	--------------------------

If YES, please give details.
If NO, why not?

--

2. How much do you agree or disagree with the following statements?

(Please circle the appropriate number in each line)

		Strongly Disagree	Disagree	Unsure	Agree	Strongly Agree
1	Mathematics is important to me.	1	2	3	4	5
2	Most people can learn to be good at maths.	1	2	3	4	5
3	My parents/carers like maths.	1	2	3	4	5
4	Maths is one of the most interesting school subjects.	1	2	3	4	5
5	Learning maths is enjoyable for me.	1	2	3	4	5
6	I have a mathematical mind.	1	2	3	4	5

	(Please circle the appropriate number in each line)	Strongly Disagree	Disagree	Unsure	Agree	Strongly Agree
7	I can get good results in maths.	1	2	3	4	5
8	I am interested in learning new things in maths.	1	2	3	4	5
9	In maths you get rewards for your effort.	1	2	3	4	5
10	Being good at maths is something you are born with.	1	2	3	4	5
11	I can learn maths even if it is hard.	1	2	3	4	5
12	I like using maths I am familiar with rather than new maths topics.	1	2	3	4	5
13	I am more worried about maths than any other subject.	1	2	3	4	5
14	I often need help with maths.	1	2	3	4	5
15	Compared to my classmates, I am good at maths.	1	2	3	4	5
16	My parents/carers enjoy solving mathematical problems.	1	2	3	4	5
17	I never want to take another mathematics course.	1	2	3	4	5
18	I would prefer my future studies to include a lot of maths.	1	2	3	4	5
19	I would look forward to studying more mathematics after school.	1	2	3	4	5
20	I would like to be a mathematician.	1	2	3	4	5
21	Maths is important for my future (after school)	1	2	3	4	5

Part C – About what you would like to do after you finish school

In this section we ask about your plans after you finish secondary school, and the people who may have an influence on these plans. Please follow the instructions for each question.

1. Which of the following options would you **prefer to do** when you finish Year 11 (after your GCSEs)? **Please write the appropriate letter from A to H in the boxes below:**

A. Continue studying at this school	1 st choice:
B. Study full-time at a college	
C. Study part-time at a college while working	2 nd choice:
D. Take an apprenticeship (a training course in a practical subject, e.g. plumbing, hairdresser, etc)	
E. Work in the family business	
F. Work in a full-time job	
G. Work in a part-time job	
H. Other If you choose 'other', please tell us what:	

2. How confident are you that you will be able to get your first choice? **(Please circle)**

Not at all confident

Somewhat confident

Very confident

3. Do you plan to continue your education after Year 11? (Tick one statement only)

Yes	
No	
I don't know	

If you chose 'Yes', please also choose one of the following options:

I will continue my education right after Year 11 (GCSEs) in secondary school	
I will continue my education after staying out of school for one year (or more)	
I will continue my education, but I don't know when	

4. Which of these might stop you from continuing your education after Year 11?

(Please tick all the boxes that apply to you)

Low GCSE grades	
Parents	
Friends	
Other relatives	
Having to leave friends and family	
I am not interested in studying	
Having to care for someone in the family	
I don't know what I really want to do	
I want to start earning money in a full-time job	
I do not like school	
I do not feel that going to school is important	
I do not have enough money	
None of the above	

5. Who will influence or inspire your decisions about what you want to do after Year 11?

(Please tick one box in each line)

	YES	Maybe	NO
My friends			
My parents			
Teachers			
My brothers or sisters			
My cousins			
Other relatives (aunts, uncles, grandparents)			
Counsellors at school			
Other (please tell us _____)			

6. What job would you like to do in the future?

Job	
Why?	

7. Do you plan to go to university? (Tick one statement only)

Yes	No	I don't know
-----	----	--------------

If you plan to go to university, what subject would you most like to study?

Subject name	
--------------	--

8. Please also tell us if you know of any people who have been to university by ticking the appropriate box in the following table:

	YES	NO	At university now	I don't know
My parents/carers				
My brothers or sisters				
My friends				
My cousins				
Other relatives (aunts, uncles, grandparents)				
Other (please tell us _____)				

Part D – How maths is taught and learnt

In this section we want to find out how maths is taught this year.

Please tell us, how often does the following happen in your maths lessons?

		Never	Rarely	Sometimes	Always
1	The teacher asks us questions.	1	2	3	4
2	The teacher asks us to explain how we get our answers.	1	2	3	4
3	The teacher starts new topics with problems about the world.	1	2	3	4
4	The teacher tells us to work more quickly.	1	2	3	4
5	The teacher uses the computer to teach some topics.	1	2	3	4
6	The teacher gives us problems to investigate.	1	2	3	4
7	The teacher expects us to remember important ideas we learned in the past.	1	2	3	4
8	The teacher tells us which questions/activities to do.	1	2	3	4
9	The teacher asks us what we already know about a lesson topic.	1	2	3	4
10	The teacher tells us what value the lesson topic has for future use.	1	2	3	4
11	We work together in groups on projects.	1	2	3	4
12	We listen to the teacher talk about the topic.	1	2	3	4
13	We copy the teacher's notes from the board.	1	2	3	4
14	We talk with other students about how to solve problems.	1	2	3	4
15	We ask other students to explain their ideas.	1	2	3	4
16	We do projects (assignments) that include other school subjects.	1	2	3	4

How often does the following happen in your maths lessons?

		Never	Rarely	Sometimes	Always
17	We work through exercises from the textbook.	1	2	3	4
18	We learn how mathematics has changed over time.	1	2	3	4
19	What we learn is related to our out-of-school life.	1	2	3	4
20	We learn that mathematics is about inventing rules.	1	2	3	4
21	We get assignments to research topics on our own.	1	2	3	4
22	We use calculators.	1	2	3	4
23	We use computers.	1	2	3	4
24	We use other things like newspapers, magazines, or video.	1	2	3	4
25	We discuss ideas with the whole classroom.	1	2	3	4
26	We explain our work to the whole class.	1	2	3	4

Please tell us how you find your maths lessons in general. (Please circle one answer)

Most of the time my maths lessons feel:	Too easy	About right	Too hard
---	----------	-------------	----------

If you use the computer or the calculators for your maths lessons, please tell us what are you using them for:

We use computers for...	
We use calculators for...	

Part E- How confident are you with different topics in mathematics?

In this section, we are asking you to say how confident you would be at using mathematics to solve different problems. **We don't ask you to actually solve the problems.**

Imagine that you have been given the following questions to do. You would be able to use your notes, textbooks, calculator, and so on when necessary. Please tell us how confident you are that you would be able to solve each problem, **without actually doing the problem.**

How confident are you that you are able to solve problems of the kind given in each case?

Please circle one response for each task.

[PLEASE DO NOT TRY TO COMPLETE THE TASKS]

1. How confident are you to solve **problems involving measurement and estimation** such as:

Here is a picture of Fred standing outside his house.



(b) Which measurement below is most likely to be the **height of Fred's house**?
Put a ring round the correct answer.

 1 metre 7 metres 17 metres 27 metres

Not confident at all Not very confident Fairly confident Very confident

2. How confident are you to **solve problems** such as:

Mr. and Mrs. Jackson are going to an exhibition with their two children, Abby and Ben.
They see this price list.

Ticket type	Cost
Children (under 6)	free
Children (under 18)	£2.25
Adults	£5.25
Family ticket (up to 2 adults and 2 children)	£12

Abby is 6 years old and Ben is 12 years old.
Calculate how much the family saves by buying a family ticket instead of separate tickets.

 £

Not confident at all Not very confident Fairly confident Very confident

3. How confident are you to **solve problems** such as:

Amir says,

'All numbers that end in a 4 are multiples of 4.'



Is he correct?
Circle **Yes** or **No**.

 Yes / No

Explain how you know.

A large, empty, cloud-shaped outline intended for the student to write their explanation.

Not confident at all Not very confident Fairly confident Very confident

4. How confident are you to solve **problems with number lines** such as:

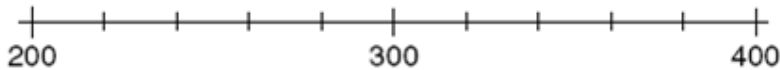

On this number line, mark the position of 270.

Not confident at all Not very confident Fairly confident Very confident

5. How confident are you to **calculate the range of a set of numbers** such as:

A rugby team played 7 games.

Here is the number of points they scored in each game.

3 5 8 9 12 12 16

(a) Work out the range.

.....

Not confident at all Not very confident Fairly confident Very confident

6. How confident are you to **solve ratio problems** such as:

Here is a list of ingredients for making 8 cheese scones.

Ingredients for 8 cheese scones

200 g self-raising flour

60 g butter

30 g cheese

150 ml milk

Work out the amount of each ingredient needed to make 12 cheese scones.

..... g self-raising flour

..... g butter

..... g cheese

..... ml milk

Not confident at all Not very confident Fairly confident Very confident

7. How confident are you to solve **problems which involve reading graphs** such as:

20 This graph shows the number of people living in a town.

Year	Number of people
1950	35000
1955	30000
1960	25000
1965	18000
1970	15000
1975	20000
1980	22000
1985	25000
1990	28000
1995	32000
2000	38000
2005	42000

Look at the graph.

Find the year when the number of people first went below 20 000



Not confident at all Not very confident Fairly confident Very confident

8. How confident are you to solve **problems** such as:

In a quiz there are ten questions.
Each correct answer gains five points.
Each wrong answer loses two points.
Glen gave seven correct answers and three wrong answers.
How many points did he get altogether?

Not confident at all Not very confident Fairly confident Very confident

[PLEASE DO NOT TRY TO COMPLETE THE TASKS]

9. How confident are you to **read coordinates** such as:

Look at the graph.

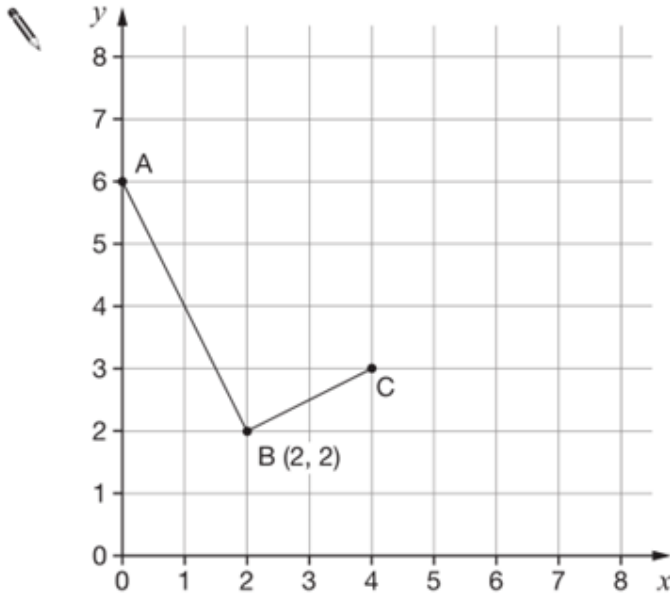

Write down the coordinates of points A and C.

A is (_____ , _____)

C is (_____ , _____)

Not confident at all

Not very confident

Fairly confident

Very confident

10. How confident are you to **solve mixed-fraction problems** such as:

Work out $4\frac{1}{5} - 1\frac{2}{3}$

Not confident at all

Not very confident

Fairly confident

Very confident

11. How confident are you to **solve number problems** such as:

Mr Gordon pays for a family holiday.

(a) Complete his bill.

Description	Cost
2 adults @ £540 each	
3 children @ £250 each	
Hire of car for 10 days @ £20 per day	
Total	£

Not confident at all Not very confident Fairly confident Very confident

12. How confident are you to solve **problems involving properties of shapes** such as:

XYZ is an isosceles triangle in which $XZ = XY$

M and N are points on XZ and XY such that angle $MYZ =$ angle NZY

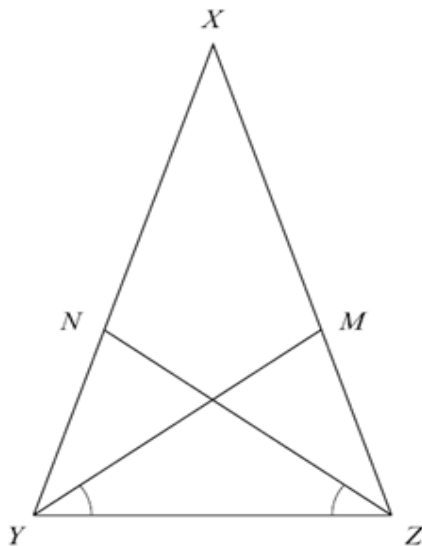

Prove that triangles YMZ and ZNY are congruent.

Not confident at all Not very confident Fairly confident Very confident

[PLEASE DO NOT TRY TO COMPLETE THE TASKS]

13. How confident are you to **solve pie-chart problems** such as:

The pie chart shows the sports played by 60 students during their games lesson.



(a) How many students play football?

.....

Not confident at all Not very confident Fairly confident Very confident

14. How confident are you to **solve problems** such as:

Here is a number chart.

Circle the **smallest** number on the chart that is a multiple of **both 2 and 7**



71	72	73	74	75	76	77	78	79	80
81	82	83	84	85	86	87	88	89	90
91	92	93	94	95	96	97	98	99	100

Not confident at all Not very confident Fairly confident Very confident

15. How confident are you to solve **problems** such as:

In this question you will need the following information about hens' eggs.

Approximate **mass**, in grams, is given by:

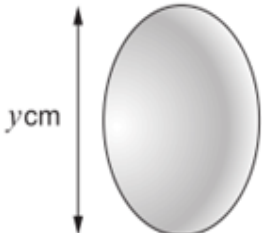
$$\text{Mass} = \frac{\pi y^3}{10} \times 1.15$$

Mass of egg	Grade of egg
Up to 53g	Small
53g up to 63g	Medium
63g up to 73g	Large
73g or more	Extra large

The length, y , of an egg is **5.5cm**.

Use the formula to find the **grade** of the egg.

You **must** show your working.



Not confident at all Not very confident Fairly confident Very confident

16. How confident are you to solve problems involving negative numbers such as:

Calculate
 $(-24) \div (+6)$

Not confident at all Not very confident Fairly confident Very confident

[PLEASE DO NOT TRY TO COMPLETE THE TASKS]

17. How confident are you to solve **percentage problems** such as:

Calculate 36% of £420.

Not confident at all Not very confident Fairly confident Very confident

18. How confident are you to solve **angle property problems** such as:

Calculate angle x .

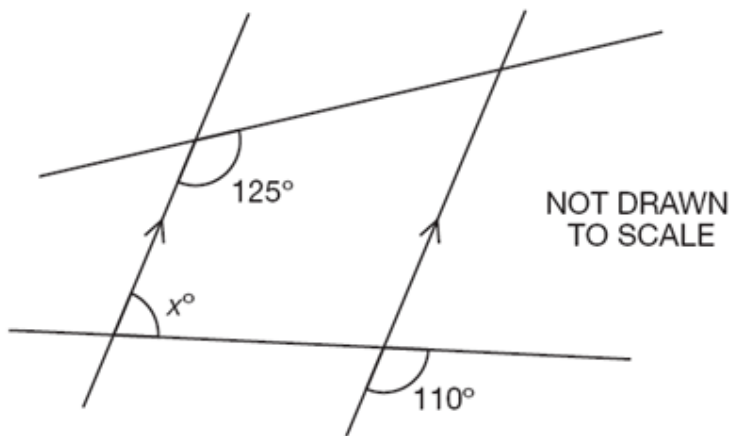

Not confident at all Not very confident Fairly confident Very confident

19. How confident are you to **simplify algebraic expressions** such as:

Simplify $2x + 8 + 4x - 3$

Not confident at all Not very confident Fairly confident Very confident

[PLEASE DO NOT TRY TO COMPLETE THE TASKS]

20. How confident are you to **solve algebraic equations** such as:

Solve for x :

$$15 - 2x = 3x + 25$$

Not confident at all Not very confident Fairly confident Very confident

21. How confident are you to **solve quadratic equations** such as:

Solve the equation:

$$(x + 3)(2x - 4) = 5$$

Not confident at all Not very confident Fairly confident Very confident

22. How confident are you to **interpret complex or unfamiliar graphs and charts** such as:

Interpret the graph below to describe how road casualties of some different age groups have changed over time.

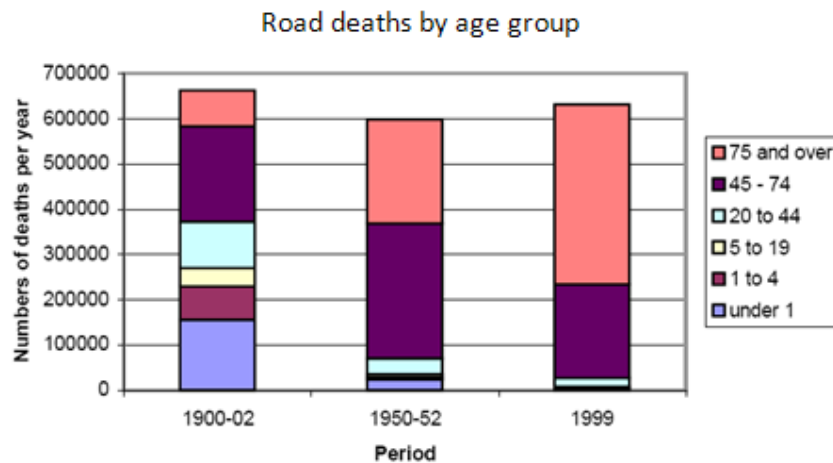

Not confident at all Not very confident Fairly confident Very confident

Thank you very much for completing the survey!

Your responses are completely anonymous and will be treated as confidential.

If you have any queries about this research project, please check our website www.teleprism.com

or contact Maria Pampaka on 0161 275 7213.

Please add any comments here, if necessary.